

Product Information

Active Power Transmitter WM500



- For 1- and 3-phase power systems with symmetric load
- Current measuring range 1 A or 5 A
- Power-factor (cos φ) selectable 0.72 or 1
- Frequency range 45..400 Hz

Characteristics

Active-power transmitter WM500 converts active-power of symmetric 1-3 phase power supply systems into proportional industry standard signals. Devices without compensating circuits can be used to measure active-power of phase-angle controlled equipments or electric motor drives controlled by frequency inverters. Devices with integrated compensating circuits (only for sinusoidal voltage) compensate errors which depends on different deviation from line voltages to nominal voltages. Both types work with any curve shape variations of the measuring current.

Error compensation

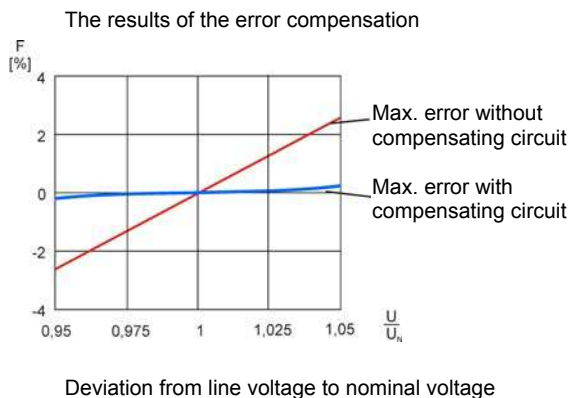

In practice an additional error up to 3 % can occur when 3-phase line voltages are not symmetrical. The WM500 with built-in compensating circuit* eliminates this error nearly completely.

*Note: The device with compensating circuit must be connected to the measuring voltage at any time of operation!

Connection diagrams

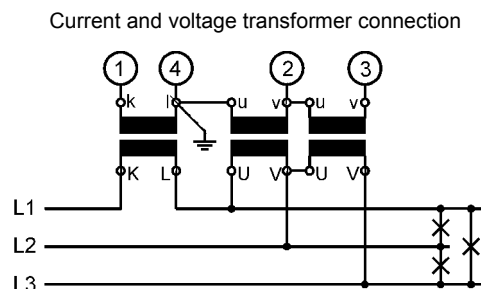
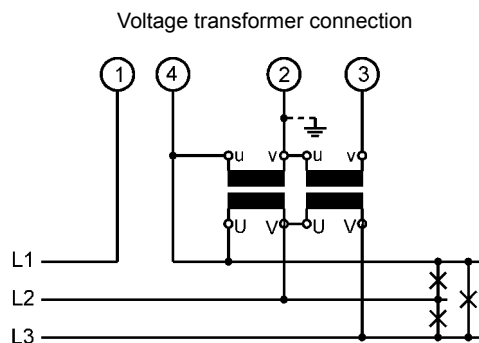
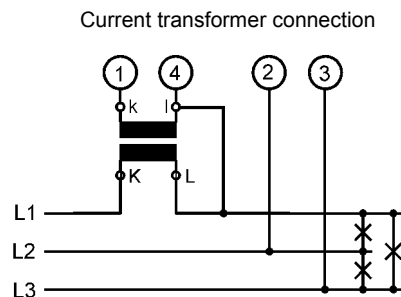
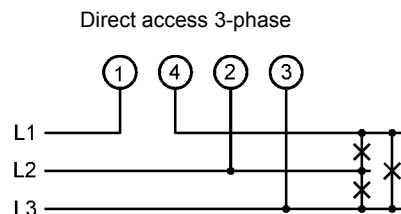
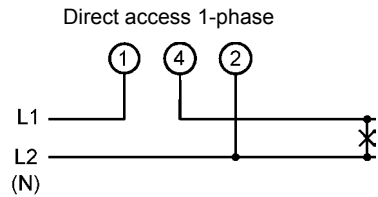

Product Information

Technical data

Power supply

Supply voltage : 230 V AC \pm 10 % or 24 V DC \pm 15 %
 Frequency : 47..63 Hz
 Power consumption: < 3 VA
 Operating temperature : -10..+50 °C
 CE-conformity : EN 61326-1:2013; EN 60664-1:2007

Inputs

Current : 0..1 A: $R_i = 82 \text{ m}\Omega$,
 over load 2-times, 4-times for max. 5 s
 0..5 A: $R_i = 10 \text{ m}\Omega$,
 over load 2-times, 4-times for max. 5 s,
Frequency range : 45..400 Hz, Crest-factor: 3
Curve shape : insignificant
Voltage : 0..440 V, $R_i = 3.4 \text{ k}\Omega/\text{V}$, over load max. 700 V
Frequency range : 45..400 Hz
Curve shape : insignificant, without compensating circuit
Curve shape : sinusoidal, with compensating circuit
End value : adjustable -30..5 %

Outputs

Programmable output
Voltage \rightarrow current : link between terminal 8 and 9
Current : 0/4..20 mA selectable, burden $\leq 500 \Omega$
Burden error : < 0.1 % ($R_L = 0 \dots 200 \Omega$),
 < 0.2 % ($R_L = 0 \dots 500 \Omega$)
Voltage : 0/2 ..10 V selectable, load max. 10 mA
Adjustment : $P = U \times I \times \sqrt{3} \times \cos\phi = 20 \text{ mA (10 V)}^*$
 * $\cos\phi=1$
Accuracy : < 0.2 %
Rise time (T_{90}) : < 500 ms

Case : Polycarbonate, UL94V-0
 TS 35 acc. to DIN EN 60715:2001-09
Weight : approx. 200 g
Connection : screw terminals, max. 2.5 mm²
Protection class : case IP30,
 terminals IP20 acc. to BGV A3

Dimensions

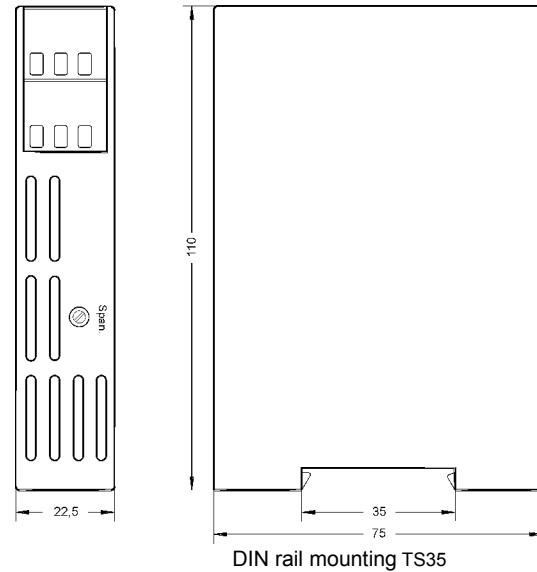

Connection diagram

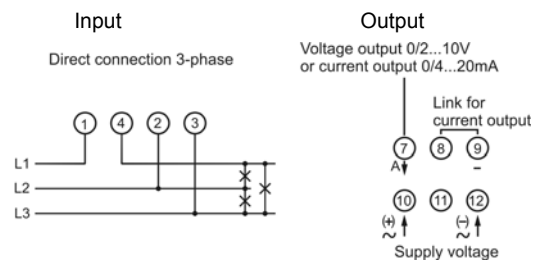

Ordering code

WM500 - 1. - 2. - 3. - 4. - 5.

1. Power supply system	
1	1-phase
3	3-phase
2. Measuring voltage	
100	100 V AC
110	110 V AC
230	230V AC
400	400 V AC
440	440 V AC
3. Measuring current	
1	1 AAC
5	5 AAC
4. Model	
1	without compensating circuit
2	with compensating circuit
5. Supply voltage	
0	230 V AC \pm 10 %
5	24 V DC \pm 15 %

Note!
 Please quote the active-power measurement range and transformation ratio of the current transformer.